

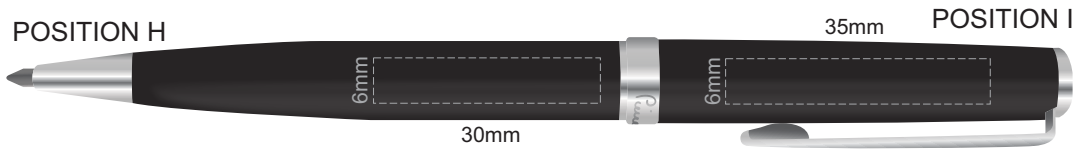

100% of Actual Size  
Pad Print

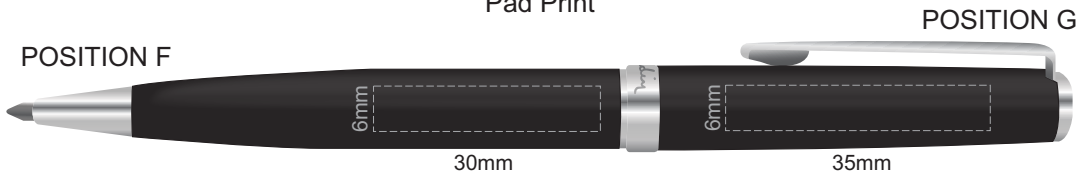

100% of Actual Size  
Laser Engraving

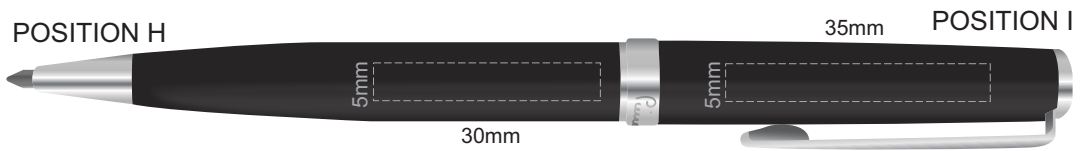
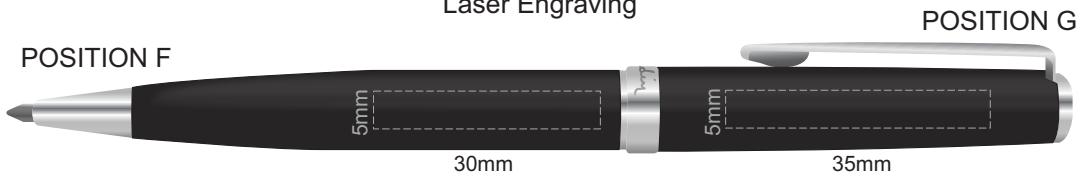

Engraves to a Silver mirror finish

100% of Actual Size  
Pad Print

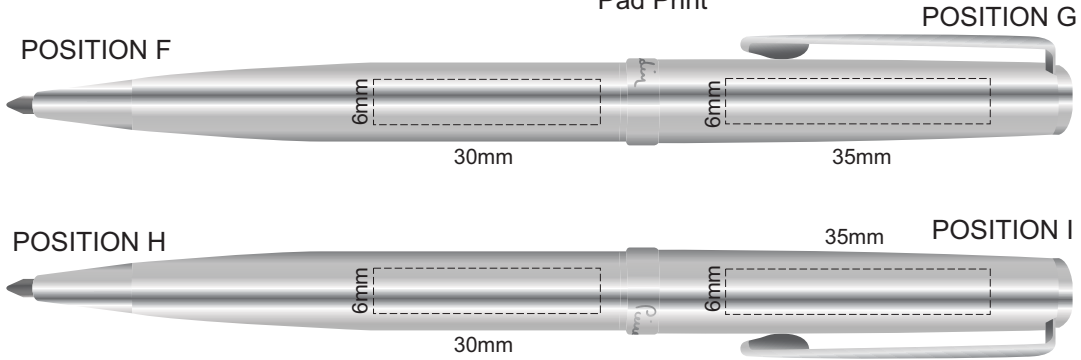

100% of Actual Size  
Laser Engraving

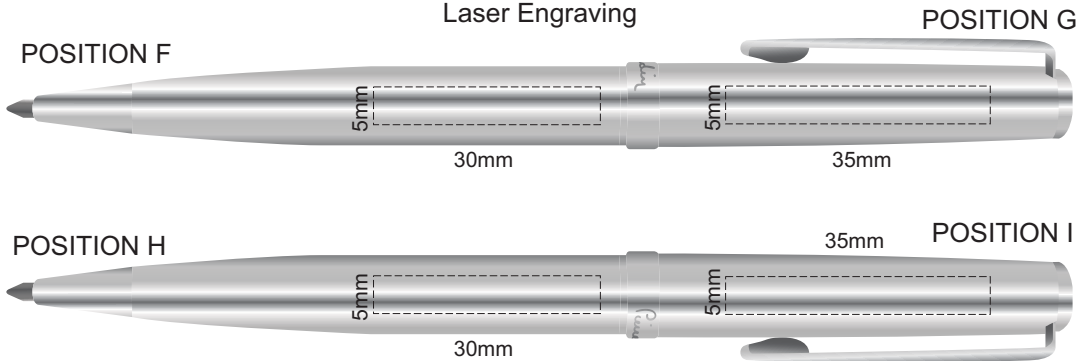

Chrome engraves to a Silver Natural Etch

100% of Actual Size  
Pad Print

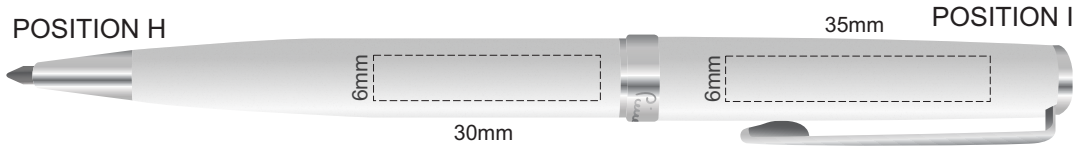
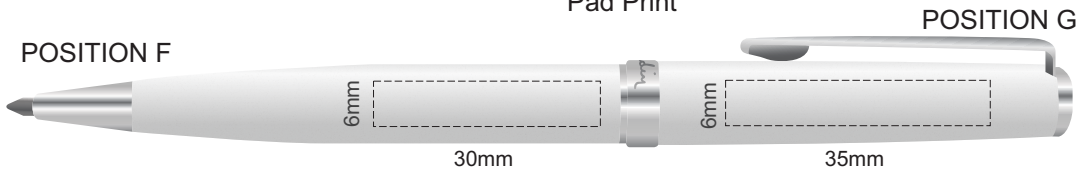

100% of Actual Size  
Laser Engraving

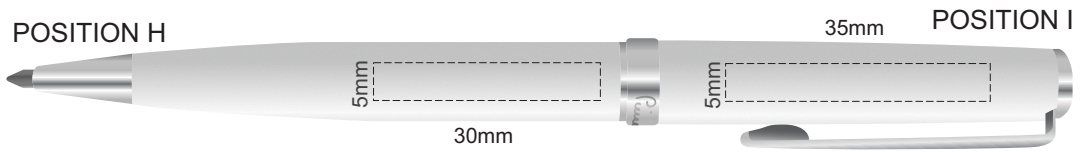
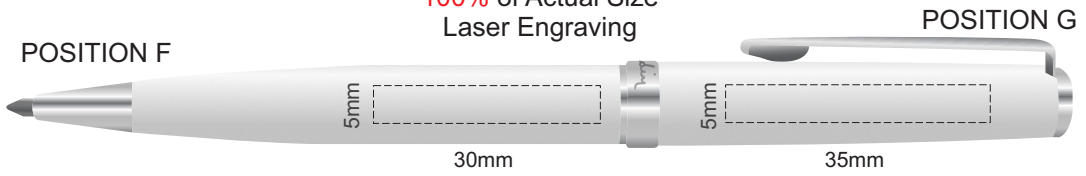

■ Matt Silver engraves to a Silver Natural Etch

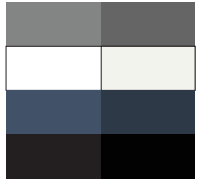

100% of Actual Size  
Thermo Debossing  
Thermo Debossing XL

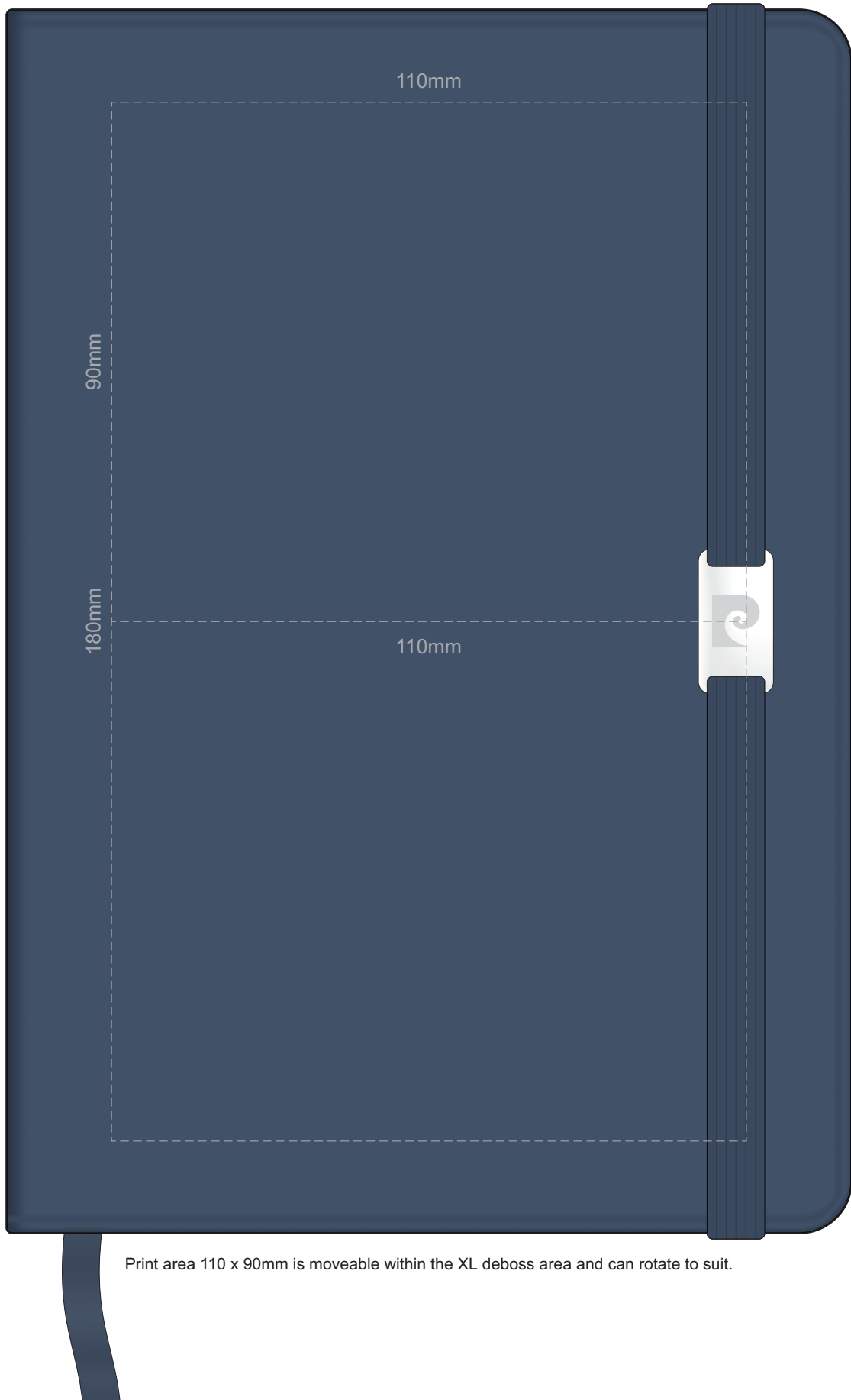

Print area 110 x 90mm is moveable within the XL deboss area and can rotate to suit.

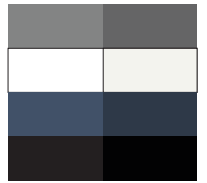

100% of Actual Size  
Thermo Debossing (back)  
Thermo Debossing XL (back)



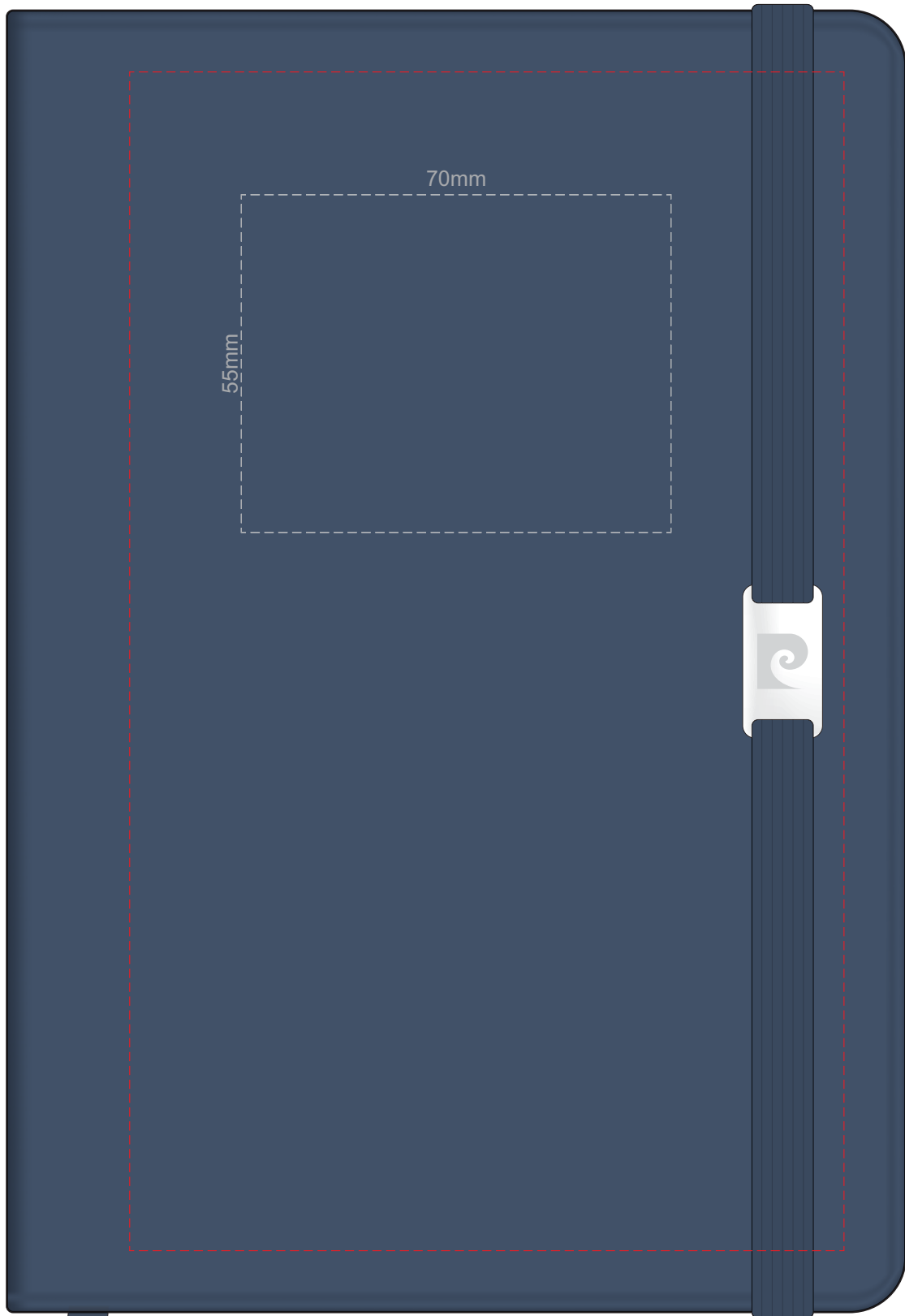

Print area 110 x 90mm is moveable within the XL deboss area and can rotate to suit.

100% of Actual Size  
Foil Printing Front Cover  
FRONT ONLY



Please note: Print area 70mm x 55mm is **moveable within the red dotted area**, the print area cannot be rotated. The printing will inherit the texture of the substrate which may affect the legibility of small text or appearance of fine detail.

-  Copper Foil Print Colour
-  Silver Foil Print Colour
-  Gold Foil Print Colour